



Growatt 17000TL3-S
Growatt 20000TL3-S
Growatt 25000TL3-S
Growatt 30000TL3-S
Growatt 33000TL3-S
Growatt 40000TL3-NS
Growatt 50000TL3-S

SHENZHEN GROWATT NEW ENERGY TECHNOLOGY CO.,LTD

No.28 Guangming Road,Shiyan Street,Bao'an District,Shenzhen,
P.R.China

T +86 755 27471942

E service@ginverter.com

W www.ginverter.com

Installation & Operation Manual ►

Introduction

Overview

This manual describes the assembly, installation, commissioning and maintenance of the following series GROWATT inverters:

Growatt 17000 TL3-S
Growatt 20000 TL3-S
Growatt 25000 TL3-S
Growatt 30000 TL3-S
Growatt 33000 TL3-S
Growatt 40000 TL3-NS
Growatt 50000 TL3-S

Target Group

This manual is for qualified personnel. Qualified personnel have received training and have demonstrated skills and knowledge in the construction and operation of this device. Qualified personnel are trained to deal with the dangers and hazards involved in installing electric devices.

Table

1 Safety

- 1.1 Warning symbols
- 1.2 Safety symbols
- 1.3 Intended Use
- 1.4 Qualification of skilled person
- 1.5 Safety instruction
- 1.6 Operation Warnings

2 Product introduction

- 2.1 Appearance
- 2.2 Size and weight
- 2.3 Type label
- 2.4 Product features

3 Unpacking

4 Installation

- 4.1 Installation steps
- 4.2 Selecting the Installation Location
- 4.3 Transport of inverter
- 4.4 Mounting the inverter
- 4.5 Type label

5 Electric connection

- 5.1 Structure of the wire box
- 5.2 Grid Type
- 5.3 Grounding
- 5.4 AC Connection
- 5.5 DC connection
- 5.6 PV module setting
- 5.7 Communication connection
- 5.8 Inverter demand response modes (DRMs, only for Australia)
- 5.9 Derating

6 Commissioning

- 6.1 Check before commissioning
- 6.2 Inverter installation plan

Safety 1

7 Display setting

- 7.1 LCD display
- 7.2 LED display
- 7.3 Inverter message
- 7.4 Knock once
- 7.5 Knock repeatedly

8 Communication

- 8.1 Shinetool
- 8.2 Monitor the inverters

9 Booting and shutdown

- 9.1 Display and message
- 9.2 Turn off the Growatt TL3-(N)S

10 Maintenance





- 10.1 Daily maintenance
- 10.2 Error and warning

11 Specification



12 Quality assurance





13 Contact

1.1 Warning symbols

Symbol	Description
 DANGER	DANGER indicates a hazardous situation which, if not avoided, will result in death or serious injury.
 WARNING	WARNING indicates a hazardous situation which, if not avoided, could result in death or serious injury.
 CAUTION	CAUTION indicates a hazardous situation which, if not avoided, could result in minor or moderate injury.
 NOTICE	NOTICE is used to address practices not related to personal injury.
 INFORMATION	INFORMATION that you must read and know to ensure optimal operation of the system.

1.2 Safety symbols

Symbol	Description
	Warning regarding dangerous voltage The product works with high voltage. All work on the product must only be performed as described in its documentation.
	Beware of hot surface The product can become hot during operation. Do not touch the product during operation.
	Earth Ground

Symbol	Description
	Observe the operating instructions Read the product's documentation before working on it. Follow all safety precautions and instructions as described in the documentation.
	DC current
	AC current
	Transformerless
	CE certificate

1.3 Intended Use

The Growatt TL3-(N)S is a PV inverter which converts the direct current (DC) of the PV array to alternating current (AC) and feeds it into the power distribution grid.

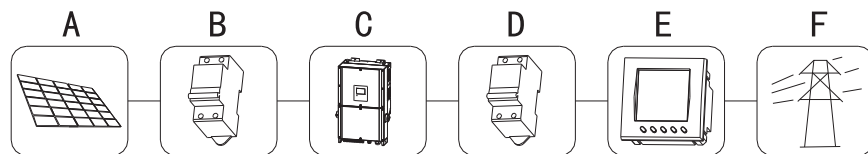

Symbol	Description
A	PV modules
B	DC load circuit breaker
C	Growatt TL3-(N)S Inverter
D	AC load circuit breaker
E	Energy meter
F	Utility grid

The Growatt TL3-(N)S takes current from PV array and converts it to alternating current for the power distribution grid (F). Energy surplus may even result in the energy meter (E) of your plant running backwards. The Growatt TL3-(N)S is suitable for indoor and outdoor use.

AC circuit breaker

Each inverter with an independent circuit breaker (three or four pole AC circuit breaker) can securely disconnect from the grid safely.

 CAUTION	<ul style="list-style-type: none"> Do not share a single circuit breaker with more than one inverter. Do not connect the any local load between the inverter and the AC circuit breaker.
--	--

PV modules

The PV modules used must be suitable for use with the Growatt TL3-(N)S and must be approved by the module manufacturer.

The PV modules must be Monocrystalline silicon PV modules, Polysilicon PV modules and thin-film PV modules with levels of protection and must not be grounded (can not have anode or cathode lead from array going to ground)

 CAUTION	<ul style="list-style-type: none"> PV modules with large capacities relative to earth, such as thin-film PV modules with cells on a metallic substrate, may only be used if their coupling capacity does not exceed 500 nF. Do not connect to any PV Modules that require the anode or the cathode to be connected directly to Ground. Do not connect any energy sources other than PV modules to the Growatt TL3-(N)S. Do not connect the any local load between the inverter and the AC circuit breaker. The Growatt TL3-(N)S is only used in the Grid-connected system.
--	---

1.4 Qualification of skilled person

This grid-tied inverter will only operate when properly connected to an AC distribution network. Before connecting the Growatt TL3-(N)S to the power distribution grid, you must contact the local power distribution grid company. This connection must be made only by qualified technical personnel, and only after receiving appropriate approvals, as required by the local authority having jurisdiction.

1.5 Safety instruction

The GROWATT TL3-(N)S Inverters is designed and tested according to international safety requirements; however, certain safety precautions must be observed when installing and operating this inverter. Read and follow all instructions, cautions and warnings in this installation manual. If questions arise, please contact Growatt's technical services at 400-833-9981.

1.5.1 Assembly Warnings

 WARNING	<ul style="list-style-type: none"> • Prior to installation, inspect the unit to ensure absence of any transport or handling damage, which could affect insulation integrity or safety clearances; failure to do so could result in safety hazards. • Assemble the inverter per the instructions in this manual. Use care when choosing installation location and adhere to specified cooling requirements. • Unauthorized removal of necessary protections, improper use, incorrect installation and operation may lead to serious safety and shock hazards and/or equipment damage. • In order to minimize the potential of a shock hazard due to hazardous voltages, cover the entire solar array with dark material prior to connecting the array to any equipment.
---	--

1.5.2 Electrical Connection Warnings

 WARNING	<ul style="list-style-type: none"> > Make all electrical connections (e.g. conductor termination, fuses, PE connection, etc.) in accordance with prevailing regulations. When working with the inverter powered on, adhere to all prevailing safety regulations to minimize risk of accidents. > Systems with inverters typically require additional control (e.g., switches, disconnects) or protective devices (e.g., fusing circuit breakers) depending upon the prevailing safety rules.
---	--

 DANGER	<ul style="list-style-type: none"> > The components in the inverter are live. Touching live components can result in serious injury or death <ul style="list-style-type: none"> • Do not open the inverter with the exception of the wire box by qualified persons. • Electrical installation, repairs and conversions may only be carried out by electrically qualified persons. • Do not touch damaged inverters. > Danger to life due to high voltages in the inverter <ul style="list-style-type: none"> • There is residual voltage in the inverter. The inverter takes 10 minutes to discharge. • Wait 10 minutes before you open the wire box.
--	--

1.6 Operation Warnings

 WARNING	<ul style="list-style-type: none"> > Anytime the inverter has been disconnected from the power network, use extreme caution as some components can retain charge sufficient to create a shock hazard; to minimize occurrence of such conditions, comply with all corresponding safety symbols and markings present on the unit and in this manual. > Ensure all covers and doors are closed and secure during operation. > All operations regarding transport, installation and start-up, including maintenance must be operated by qualified, trained personnel and in compliance with all superseding codes and regulations. > Although designed to meet all safety requirements, some parts and surfaces of Inverter are still hot during operation. To reduce the risk of injury, do not touch the heat sink at the back of the PV-Inverter or nearby surfaces while Inverter is operating. > Incorrect sizing of the PV plant may result in voltages being present which could destroy the inverter. The inverter display will read the error message "PV-Overvoltage!" <ul style="list-style-type: none"> • Turn the rotary switch of the DC Disconnect to the Off position immediately. • Contact installer.
---	--

2 Product introduction

2.1 Appearance

The front view:

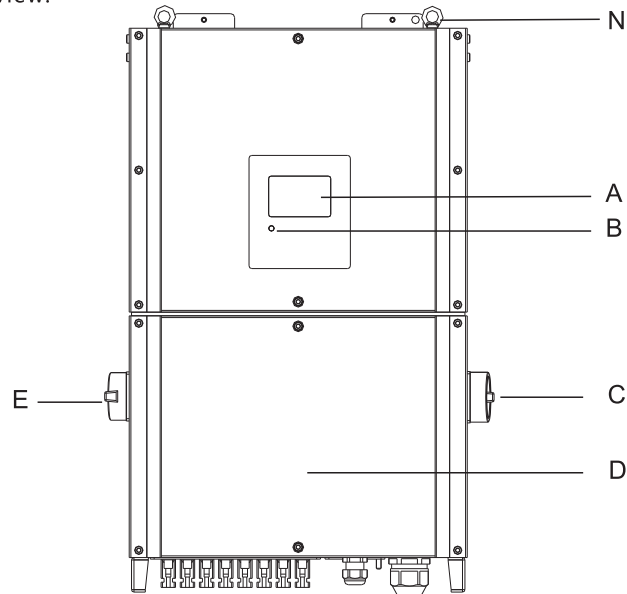

The side view:

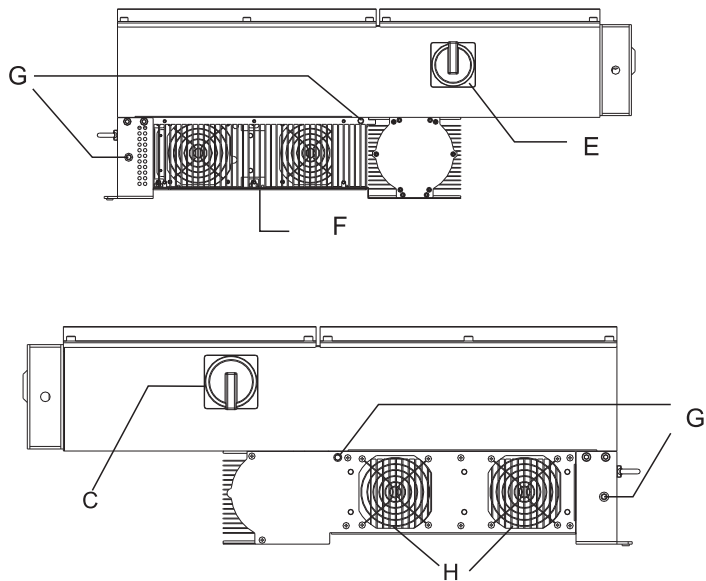

The bottom view:

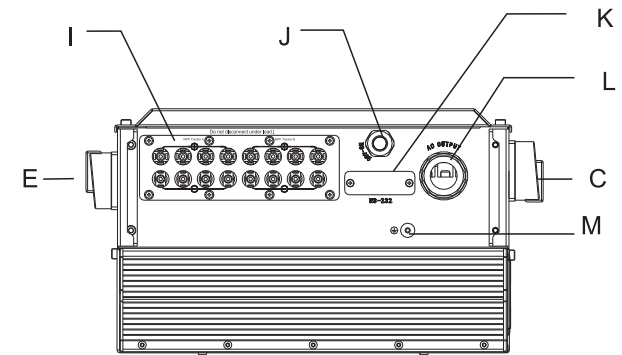

Item	Description	Item	Description
A	LCD	B	LED
C	AC switch(opt)	D	Wire box
E	DC switch	F	Heat sink
G	Hand shank	H	Fan
I	DC terminal	J	RS 485 Plug DRM Plug
K	RS 232 port	L	AC plug
M	PE	N	Flying rings

2.2 Size and weight

Inverter Only			
Dimension			Weight
Width	Height	Depth	
470 mm	754mm	270mm	48kg
18.5 inch	29.68 inch	10.63inch	105.8lb
Inverter with Packaging			
Dimension			Weight
Width	Height	Depth	
550 mm	900mm	435mm	55.3kg
21.65 inch	35.43 inch	17.12inch	121.9lb

TABLE 2-2

Note: The width of the version with AC switch is 470mm, the width of the version without AC switch is 440mm.

2.3 Product features

Feature	Description
High efficiency	The Europe efficiency 98.5% , Max efficiency 99%.
High power density	Smaller and lighter inverter , can be installed easily.
2 MPPTs	Dual independent MPP trackers and advanced MPPT algorithms lead to optimal energy harvesting . Adapt to different installations of strings or illumination variation.
Wide voltage range	Operating PV voltage range 200V~1000V. Wide range of output power allows a variety of site designs, with an emphasis on design flexibility and project yield.

Feature	Description
ECO mode	Gets higher MPP precision and efficiency especially under weak illumination.
Anti-PID	Eliminate PV modules PID effect.
String Monitor	Monitor the working status of each PV string.
AC Power Supply	Inverter can still be monitored and updated when PV power turned off.
AFCI	Arc fault circuit interruption.(OPT)
Flexible Communication	RS485/RS232/WiFi (OPT)/GPRS (OPT).
Intelligent Integration	Integrated DC switch, DC fuse, DC/AC SPD (ClassII), AC switch (OPT), save place and cost of installation.
Comprehensive Protection	Overvoltage, anti-island, DC insulation resistance low, ground fault ,output short-circuit, overload, overheat, etc
Inverter topology	New 3 levels invert topology, gets higher efficiency.
LCL topology	LCL topology, higher quality of output power, adapt to multiple parallel connection.
IGBT driver	Advanced IGBT drivers, insure rapid short-circuit and over-voltage protection for IGBTs
New IGBT	Using the new IGBT technology, achieve high performance indicators.
Long life	Full film capacitor design on DC link, longer lifetime for inverter.
Patented inductor	Patent inductor design approach to ensure good operating conditions and performance.

Unpacking 3

Feature	Description
High power quality	Flexible power quality, to ensure that the user power quality, no noise, the output power quality intelligent management, to adapt to the complex power grid.
Anti-corrosion paint	Anti-corrosion paint protection, to achieve a higher reliability and life expectancy in complex application field.



WARNING

- The inverter is too heavy and large to keep balance, be carefully in the process of transport to avoid bruising or hurting operator.
- PV connector and the signal line in the bottom of the inverter can not bear weight, do not contact the ground directly. Please place the inverter horizontal.
- Place the foam or cardboard beneath the machine when the inverter is placed on the ground in case that it damages the shell.

After opening the package, please check the contents of the box. It should contain the following parts:

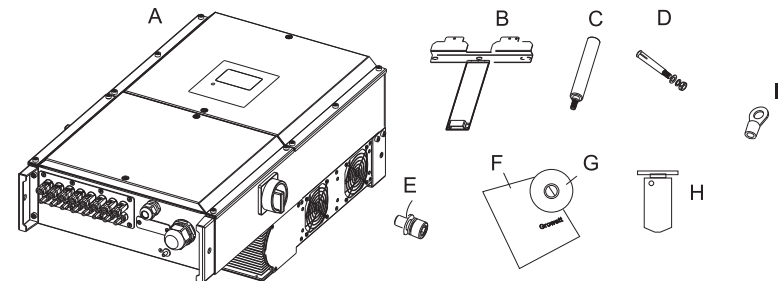

Item	Quantity	Name
A	1	Solar inverter
B	1	Mounting bracket
C	4(opt)	Hand shank
D	3	Expansion bolt
E	6	Safety-lock screws
F	1(opt)	Disk
G	1	Manual
H	1(opt)	External wireless
I	5/4	AC cable terminal (5PCS for 30kW/33kW/40kW,4PCS for50kW)

4 Installation



WARNING

- Before instructions, anyone includes qualified, trained personnel, must make sure you have read the section 2.1, about the General installation warnings.

4.1 Installation steps

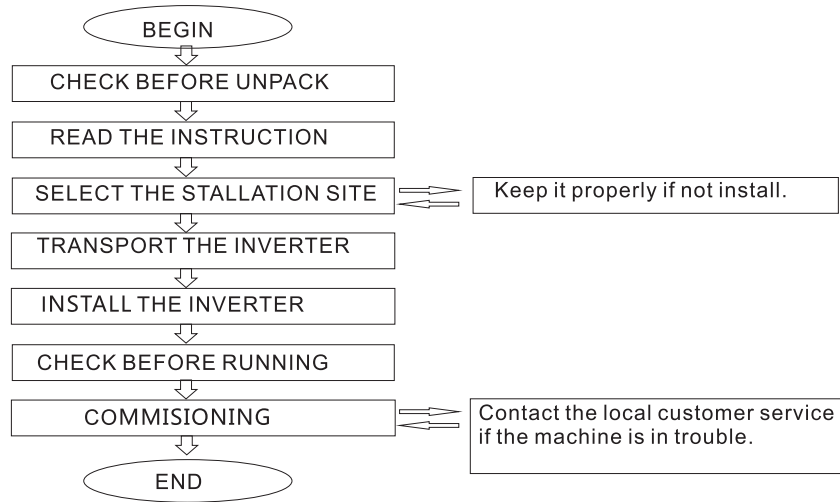

- 1) Check before installation
You need to check whether the packaging is intact before unpack; after the unpacking, and check whether accessories are all there, and whether the package is damaged.
- 2) Choose installation location
You need to select the appropriate location for the inverter, to ensure that the inverter can work properly and efficiently.
- 3) Handling inverter
Please remove the inverter from the package and carry it to the specified installation location.
- 4) Install the mounting bracket
You need to install the mounting bracket first, so that the inverter can be firmly installed on the the wall.
- 5) Install the inverter
Install the inverter to the mounting bracket and fixed it with bolts.

4.2 Selecting the Installation Location

Select the installation location based on the following considerations:

- 1) Select a well-ventilated location sheltered from direct sunlight and rain.
- 2) Choose a location that allows unobstructed airflow around the inverter.
- 3) Allow sufficient room around the inverter to enable easy installation and removal from the mounting surface.
- 4) Height from ground level should be at least 3 feet.
- 5) Access panels on the front surface of the inverter allow inspection and maintenance of hardware; and must not be blocked. See Figure on pg. 14 for recommended minimum clearances around the inverter.
- 6) Mount the Growatt TL3-(N)S Inverter vertically as possible. For other mounting orientations, please consult with Growatt.
- 7) Tilted mounting (0° from vertical) is acceptable for the Growatt17000-50000TL3-(N)S.
- 8) The inverter requires adequate cooling space, allowing at least 19.5” inches (50cm) space above and below the inverter while 19.5” inch (50cm) space of right and left.
- 9) The installation method and mounting location must be suitable for the weight and dimensions of the inverter. Select a wall or solid vertical surface that can support the PV-Inverter.
- 10) The location shall be away from strong electromagnetic interference.
- 11) The location shall not exceed IP 65 standard.
- 12) We recommend using a shading shed to reduce the derating of the inverter due to direct sunlight.

Possible location for inverter under the ceiling:

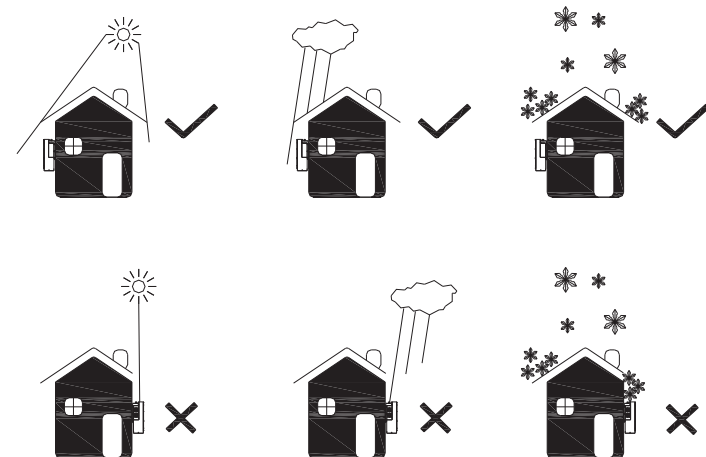

Minimum clearances around the inverter:

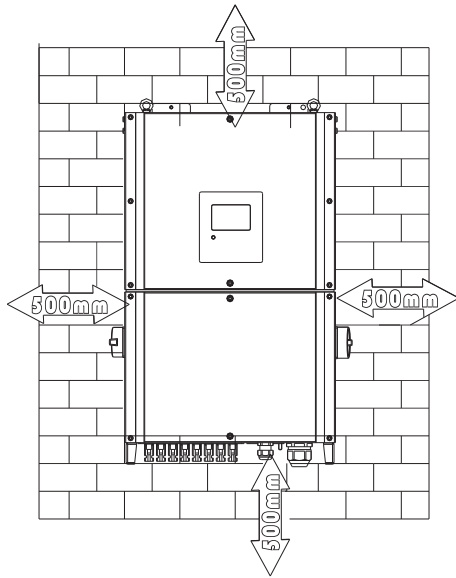

DO NOT install the inverter into a small enclosure:

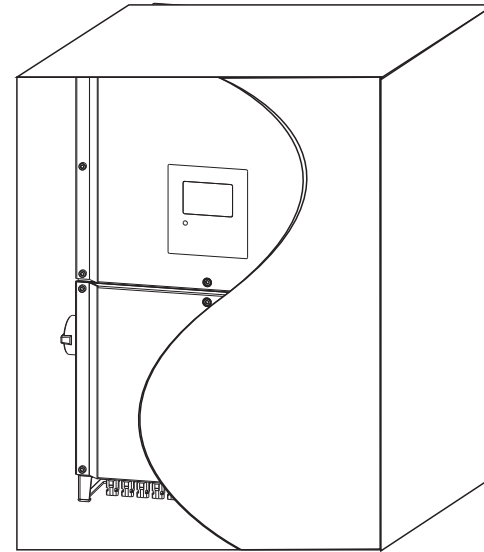

Clearances for multi inverters:

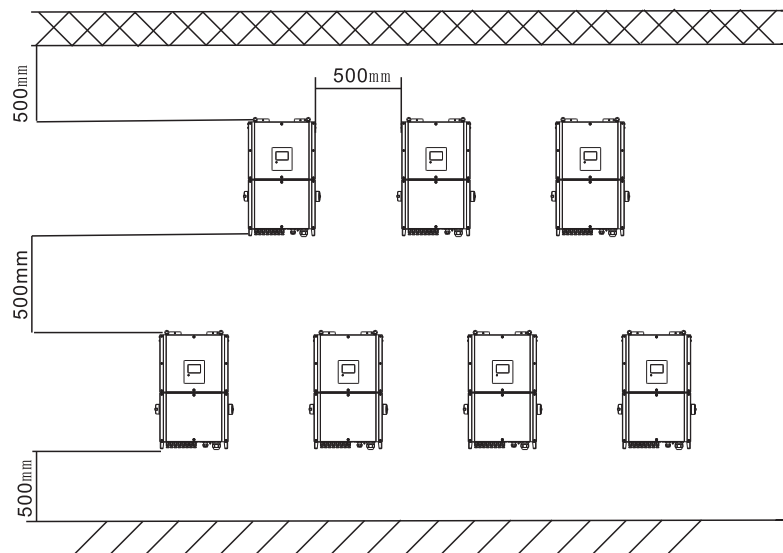

Tilted mounting (0° from vertical) is acceptable for the inverter following the picture below:

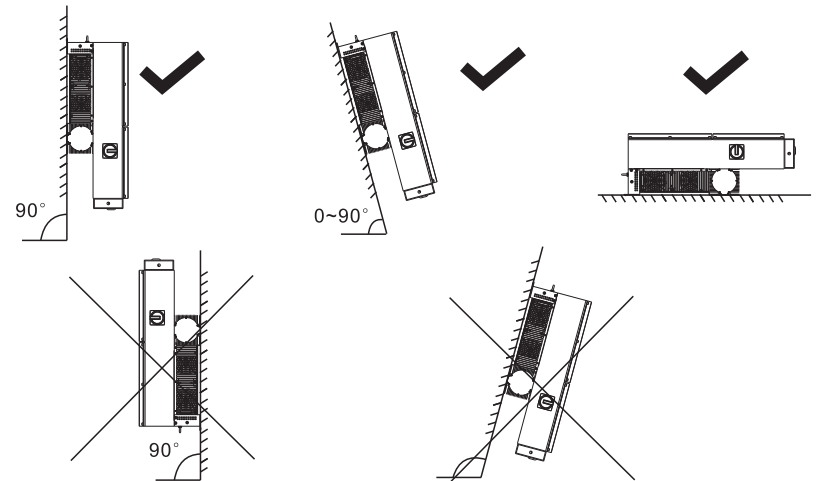

The distance between the inverter and shading shed:

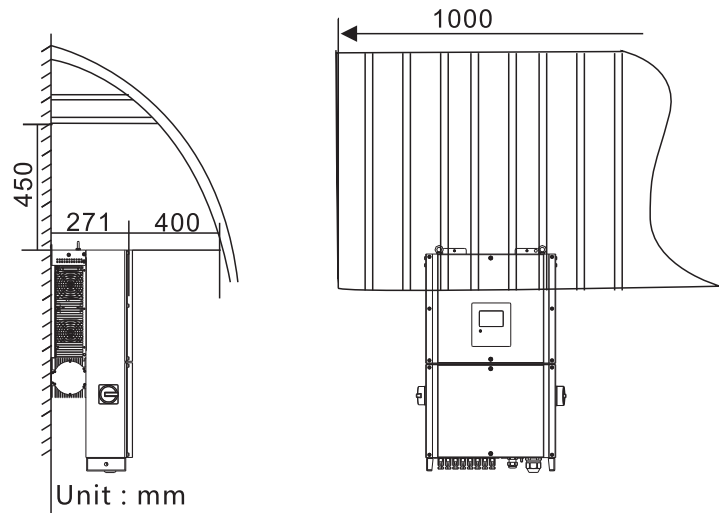

4.3 Transport of inverter

Transport steps:

1. Use the device to lift the inverter from the packing box to the specified installation location.
2. Please keep the balance of the inverter when hang it on the mounting bracket, as shown below:

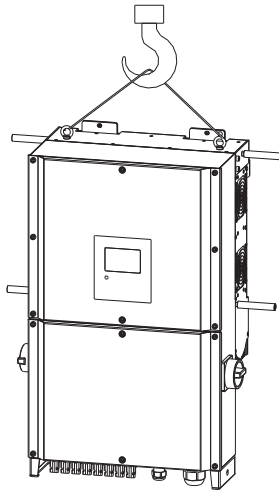

3. In order to ensure that the inverter can be reliably fixed to the wall, fix the side of the inverter with a M6*10 screw, as shown below:

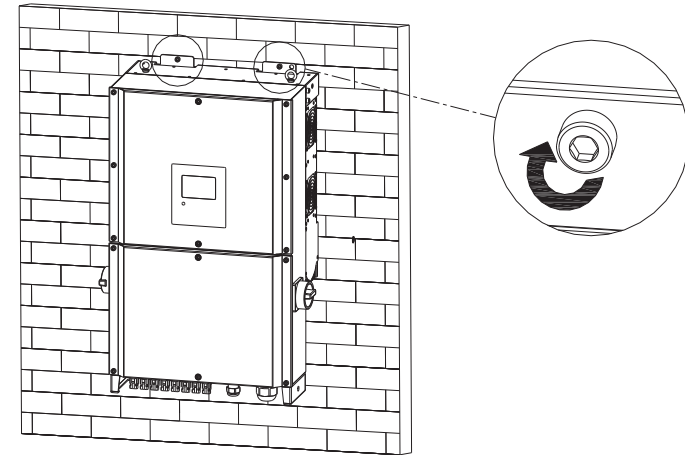

4. Tighten all screws to ensure safety.

5. Lock protection ground wire.

6. Connect the protection ground wire (PE), connect the inverter with the earth.

4.4 Mounting the inverter

 INFORMATION	<ul style="list-style-type: none"> > General tools <ul style="list-style-type: none"> ● Personal safety equipment such as gloves, helmet, goggles, ear plugs, safety harness etc. ● Step ladders. ● Knife. > Tools for mechanical installation <ul style="list-style-type: none"> Equipment for transporting and lifting the inverter. ● Electric (hammer) drill. ● Hammer. ● Set of drill bits, wrenches, sockets and screw bits. ● Socket driver, screwdriver. ● Tape measure. ● Spirit level. ● Pencil or other marker. ● Fastening screws, plugs, etc
---	---

Step 1: Drilling mounting holes for bracket

Use the mounting bracket as a template and drill 3 holes as illustrated in image below, hole size: 10mm (diameter), 85mm (min. depth). Then insert the 3 expansion bolts provided into the holes, make sure the bolts are paralleled with the outer surface of the bracket.



INFORMATION

For Growatt 170000-50000TL3- (N) S, 3 holes must to be drilled. The space between holes is 196.5mm, as figure below.

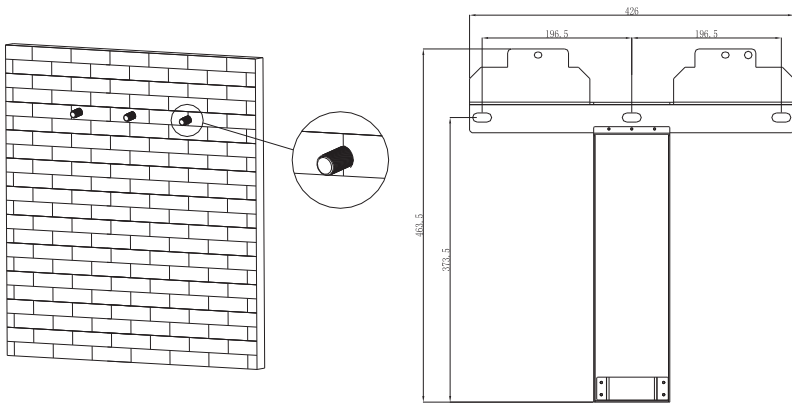

Step 2: Installing the bracket

Place and hold the bracket onto the wall and screw on the nuts to fasten the bracket, as the figure below.

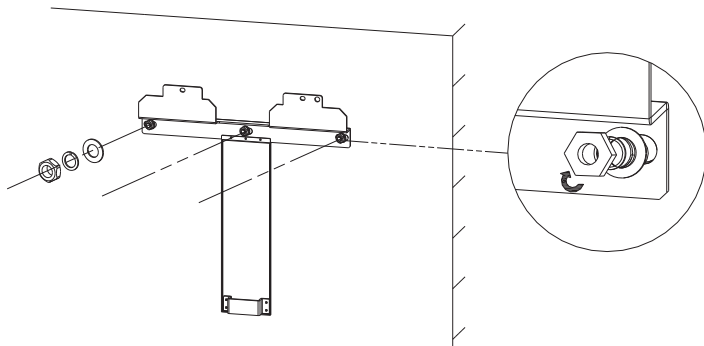

Step 3: Mounting the inverter on the wall

Raise the Growatt TL3-(N)S a little higher than the bracket. Due to the weight of the inverter, additional tools may be required to hang the inverter using the right and left fly rings on the top of the inverter. Make sure to maintain the balance of the Growatt TL3-(N)S during the process, as shown on figure below.

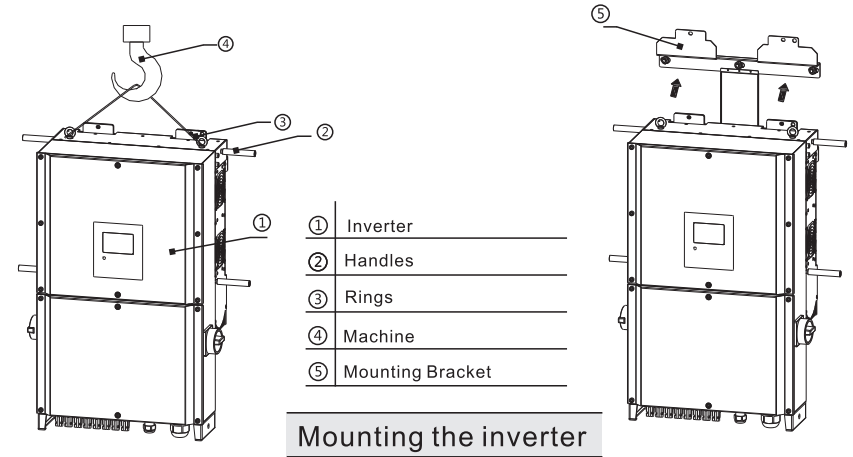

Step 4: Insert safety-lock screws

Insert the safety-lock screws into the two side holes of the mounting bracket to fasten the inverter, as shown on figure below

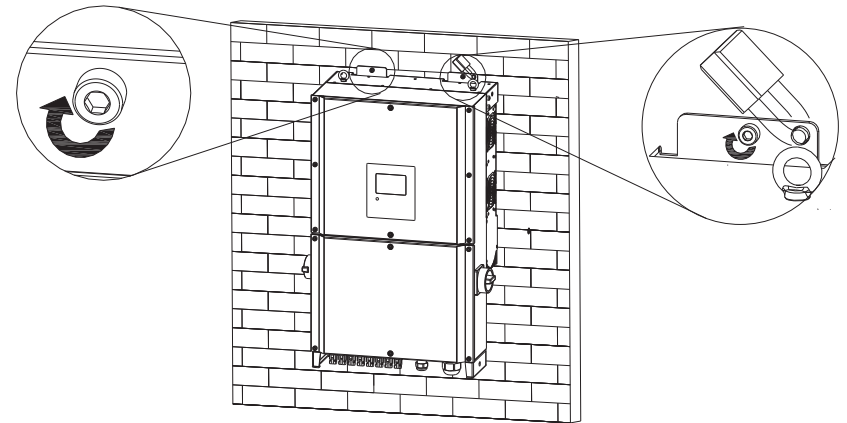

Step 5: Check

Check the upper straps of PV Inverter and ensure it is secured on to the bracket.

Check for secure mounting of the PV inverter by trying to raise it from the bottom. The PV Inverter should remain firmly attached.

4.5 Type label

The type labels provide a unique identification of the inverter (The type of product, Device-specific characteristics, Certificates and approvals). The type labels are on the right-hand side of the enclosure.

Growatt PV Grid Inverter	
Model name	Growatt17000TL3-S
Max. PV voltage	1000V
PV voltage range	200V-1000V
PV Isc	45A
Max. input current	37.5A
Max. output power	17000W
Max. apparent power	18800VA
Nominal output voltage	230V/400V
Max output current	27.5A
Nominal output Frequency	50/60 Hz
Power factor range	0.8leading-0.8lagging
Safety level	Class II
Ingress Protection	IP65
Operation Ambient Temperature	-25°C - +60°C
Certificate Number	SAA162120

Growatt PV Grid Inverter	
Model name	Growatt20000TL3-S
Max. PV voltage	1000V
PV voltage range	200V-1000V
PV Isc	45A
Max. input current	37.5A
Max. output power	20000W
Max. apparent power	22200VA
Nominal output voltage	230V/400V
Max output current	32.2A
Nominal output Frequency	50/60 Hz
Power factor range	0.8leading-0.8lagging
Safety level	Class II
Ingress Protection	IP65
Operation Ambient Temperature	-25°C - +60°C
Certificate Number	SAA162120

Growatt PV Grid Inverter	
Model name	Growatt25000TL3-S
Max. PV voltage	1000V
PV voltage range	200V-1000V
PV Isc	45A
Max. input current	37.5A
Max. output power	25000W
Max. apparent power	27700VA
Nominal output voltage	230V/400V
Max output current	40.3A
Nominal output Frequency	50/60 Hz
Power factor range	0.8leading-0.8lagging
Safety level	Class II
Ingress Protection	IP65
Operation Ambient Temperature	-25°C - +60°C
Certificate Number	SAA162120

GROWATT PV Grid Inverter	
Model Name	Growatt 30000TL3-S
Max. DC voltage	1000 d.c.V
DC voltage range	200-1000 d.c.V
MPPT voltage range	450-800 d.c.V
Max. input current	2*34 d.c.A
Max. apparent power	33300 VA
Nominal output current	3*44 a.c.A
Nominal output voltage	3W/N/PE 230 / 400 a.c.V
AC Frequency	50Hz
Power Factor	0.9leading-0.9lagging
Safety Level	Class I
Protection Degree	IP65
Operation Ambient Temperature	-25°C - +60°C
VDE0126-1-1	

GROWATT PV Grid Inverter	
Model Name	Growatt 33000TL3-S
Max. DC voltage	1000 d.c.V
DC voltage range	200-1000 d.c.V
MPPT voltage range	450-800 d.c.V
Max. input current	2*38 d.c.A
Max. apparent power	36600 VA
Nominal output current	3*48 a.c.A
Nominal output voltage	3W/N/PE 230 / 400 a.c.V
AC Frequency	50Hz
Power Factor	0.9leading-0.9lagging
Safety Level	Class I
Protection Degree	IP65
Operation Ambient Temperature	-25°C - +60°C
VDE0126-1-1	

GROWATT PV Grid Inverter	
Model Name	Growatt 40000TL3-NS
Max. DC voltage	1000 d.c.V
DC voltage range	200-1000 d.c.V
MPPT voltage range	540-800 d.c.V
Max. input current	2*48 d.c.A
Max. apparent power	44400 VA
Nominal output current	3*58 a.c.A
Nominal output voltage	3W/N/PE 230 / 400 a.c.V
AC Frequency	50Hz
Power Factor	0.9leading-0.9lagging
Safety Level	Class I
Protection Degree	IP65
Operation Ambient Temperature	-25°C - +60°C
VDE0126-1-1	

GROWATT PV Grid Inverter	
Model Name	Growatt 50000TL3-S
Max. DC voltage	1000 d.c.V
DC voltage range	200-1000 d.c.V
MPPT voltage range	645-850 d.c.V
Max. input current	2*38 d.c.A
Max. apparent power	53300 VA
Nominal output current	3*58 a.c.A
Nominal output voltage	3W/PE 277 / 480 a.c.V
AC Frequency	50Hz
Power Factor	0.9leading-0.9lagging
Safety Level	Class I
Protection Degree	IP65
Operation Ambient Temperature	-25°C - +60°C
VDE0126-1-1	

Aus. type label.

Growatt PV Grid Inverter	
Model name	Growatt17000TL3-S
Max. PV voltage	1000V
PV voltage range	200V-1000V
PV Isc	45A
Max. input current	37.5A
Max. output power	17000W
Max. apparent power	18800VA
Nominal output voltage	230V/400V
Max output current	27.5A
Nominal output Frequency	50/60 Hz
Power factor range	0.8leading-0.8lagging
Safety level	Class II
Ingress Protection	IP65
Operation Ambient Temperature	-25°C - +60°C
Certificate Number	SAA162120

Growatt PV Grid Inverter	
Model name	Growatt20000TL3-S
Max. PV voltage	1000V
PV voltage range	200V-1000V
PV Isc	45A
Max. input current	37.5A
Max. output power	20000W
Max. apparent power	22200VA
Nominal output voltage	230V/400V
Max output current	32.2A
Nominal output Frequency	50/60 Hz
Power factor range	0.8leading-0.8lagging
Safety level	Class II
Ingress Protection	IP65
Operation Ambient Temperature	-25°C - +60°C
Certificate Number	SAA162120

Growatt PV Grid Inverter	
Model name	Growatt25000TL3-S
Max. PV voltage	1000V
PV voltage range	200V-1000V
PV Isc	45A
Max. input current	37.5A
Max. output power	25000W
Max. apparent power	27700VA
Nominal output voltage	230V/400V
Max output current	40.3A
Nominal output Frequency	50/60 Hz
Power factor range	0.8leading-0.8lagging
Safety level	Class II
Ingress Protection	IP65
Operation Ambient Temperature	-25°C - +60°C
Certificate Number	SAA162120

GROWATT PV Grid Inverter	
Model Name	Growatt 30000TL3-S
Max. DC voltage	1000 d.c.V
DC voltage range	200-1000 d.c.V
MPPT voltage range	450-800 d.c.V
PV Isc	2*64 d.c.A
Max. apparent power	33300 VA
Nominal output current	3*44 a.c.A
Nominal output voltage	3W/N/PE 230 / 400 a.c.V
AC Frequency	50Hz
Power Factor	0.8leading-0.8lagging
Safety Level	Class I
Protection Degree	IP65
Operation Ambient Temperature	-25°C - +60°C
Certificate Number	

GROWATT PV Grid Inverter	
Model Name	Growatt 33000TL3-S
Max. DC voltage	1000 d.c.V
DC voltage range	200-1000 d.c.V
MPPT voltage range	450-800 d.c.V
PV Isc	2*64 d.c.A
Max. apparent power	36600 VA
Nominal output current	3*48 a.c.A
Nominal output voltage	3W/N/PE 230 / 400 a.c.V
AC Frequency	50Hz
Power Factor	0.8leading-0.8lagging
Safety Level	Class I
Protection Degree	IP65
Operation Ambient Temperature	-25°C - +60°C
Certificate Number	

GROWATT PV Grid Inverter	
Model Name	Growatt 40000TL3-NS
Max. DC voltage	1000 d.c.V
DC voltage range	200-1000 d.c.V
MPPT voltage range	540-800 d.c.V
PV Isc	2*64 d.c.A
Max. apparent power	44400 VA
Nominal output current	3*58 a.c.A
Nominal output voltage	3W/N/PE 230 / 400 a.c.V
AC Frequency	50Hz
Power Factor	0.8leading-0.8lagging
Safety Level	Class I
Protection Degree	IP65
Operation Ambient Temperature	-25°C - +60°C
Certificate Number	

GROWATT PV Grid Inverter	
Model Name	Growatt 50000TL3-S
Max. DC voltage	1000 d.c.V
DC voltage range	200-1000 d.c.V
MPPT voltage range	645-850 d.c.V
PV Isc	2*64 d.c.A
Max. apparent power	53300 VA
Nominal output current	3*58 a.c.A
Nominal output voltage	3W/PE 277 / 480 a.c.V
AC Frequency	50Hz
Power Factor	0.8leading-0.8lagging
Safety Level	Class I
Protection Degree	IP65
Operation Ambient Temperature	-25°C - +60°C
Certificate Number	

5 Electric connection

5.1 Structure of the wire box

Internal layout of the wire box is shown as below:

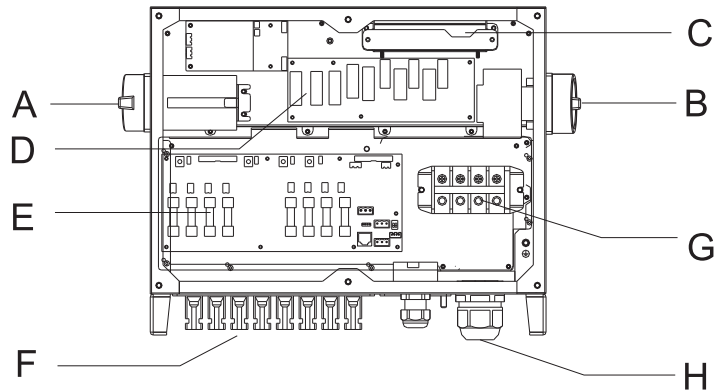

A	DC switch	B	AC switch(opt)
C	Internal fan	D	DC&AC SPD
E	Fuse	F	DC terminal
H	AC waterproof plug	G	AC terminal block

5.2 Grid Type

Based on the local GRID standards, one may select different connection types. The available configurations are shown as below, 17-33K TL3-S and 40K TL3-NS select the left type below, 50K TL3-S select the right type below:

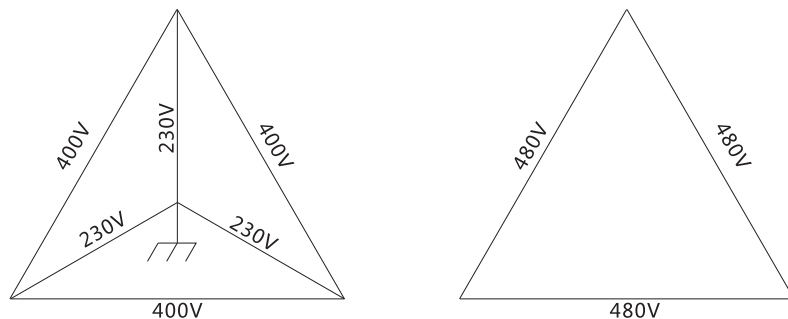

5.3 Grounding

AC Grounding

The inverter must be connected to the AC grounding conductor of the power distribution grid via the ground terminal (PE).



Grounding Electrode Terminal (GET)

A grounding electrode terminal may be required to local regulations.

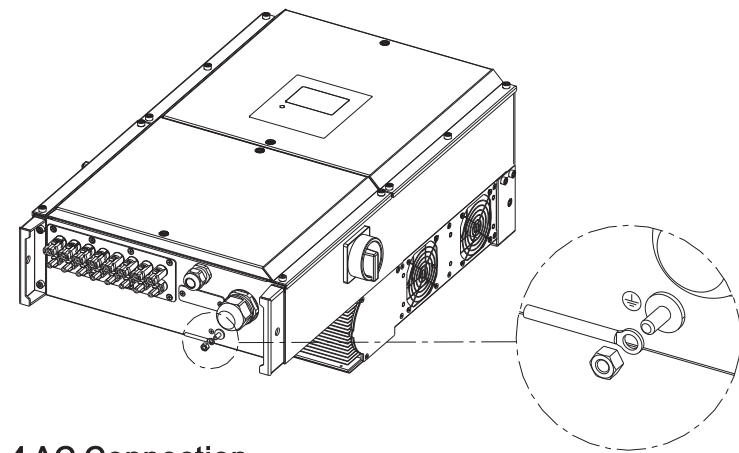
Remove the nut from the bottom of the machine, and lock the ground wire like the diagrammatic drawing below:



5.4 AC Connection

 DANGER	<ul style="list-style-type: none"> ● Before the electrical connection, make sure the inverter DC switch is in the "OFF" state, and disconnect the AC side.
 WARNING	<ul style="list-style-type: none"> ● Each inverter must be installed with an AC circuit breaker independently, and not sharing it among multiple inverters. ● Do not connect to load between inverter and circuit breaker. ● Do not use single core wire for inverter output. ● The wire is thick, heavy, please make sure that the output line is well connected before starting the inverter. If the user ignore the warning that may damage the machine or cause other losses.

The preparation work before wiring :

- A. Disconnect inverter DC switch, AC side circuit breaker or switch.
- B. When screwing to lock the AC cable, screwing torque is 2.0N·m.
- C. Measure the voltage and frequency of the AC grid (rated voltage of the 50000 TL3-S is 480Vac; Nominal voltage of the 17000-33000 TL3-S and 40000 TL3-NS is 400Vac; nominal frequency : 50Hz or 60Hz).

Specification of AC Switch :

MODEL	AC switch specification
17000TL3-S	40A/400V
20000-33000TL3-S	63A/400V
40000TL3-NS	80A/400V
50000TL3-S	80A/480V

Specification of AC cable :

MODEL	Conductor cross section (mm ²)	Recommend conductor cross section (mm ²)	Max AC cable length (m)
17000TL3-S	6-10	6	20
20000-25000TL3-S	10-16	10	23
30000TL3-S	10-16	10	23
33000TL3-S	10-16	16	37
40000TL3-NS	14-20	16	30
50000TL3-S	14-20	16	35

Steps of AC wiring:



WARNING

- As the cable is thick, do not pull or shake the cable after tightening the wire. Otherwise it may cause cable loose, after long time running it may lead to damage for overheating.

1. Open the wire box of the Growatt TL3-(N)S.

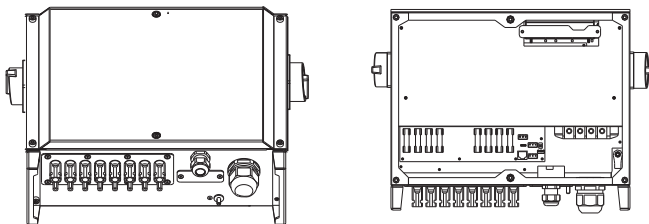

2. Remove the AC rubber grommet.
3. Feed the conductors through the rubber grommet into the wire box.
4. Pull the conductors back slightly so as to seal the rubber grommet.

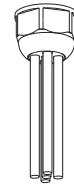
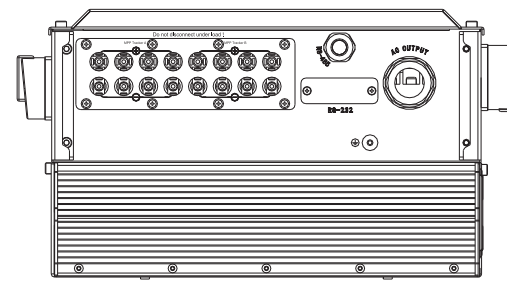

B. Feed the conductors



A. remove the grommet



Crimp the terminal , show as below :

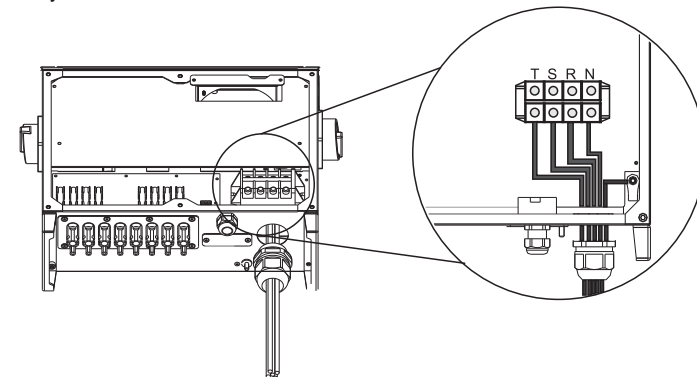

5. Connect the AC device grounding green-yellow conductor to the PE terminal, black conductor to the terminal labeled N and the red wire conductors to the terminals labeled L1(AC conductor A), L2(AC conductor B), L3(AC conductor C) separately .



5.5 DC connection

 DANGER	<ul style="list-style-type: none"> Do not touch the electric parts, and connect the terminal to the inverter carefully to avoid electric shock. Ensure that the AC and DC switches are disconnected before operation. Do not place flammable materials around the inverter.
 WARNING	<ul style="list-style-type: none"> The maximum voltage of each series PV module shall not exceed 1000Vdc under any conditions. Please ensure that the following conditions are met, otherwise it may result in fire hazard or damage to the inverter. In this case, the company does not assume neither liability nor warranty.

- A. Each PV modules must be the same model.
 B. The maximum short circuit current of each PV string is no more than 12A under any conditions.
 C. Sum of the modules power for one inverter should not be more than 1.25 times of the inverter rated input power.
 D. In order to optimize the system configuration, the two inputs are recommended to be connected to the same number of PV modules.
 E. If the inverter output is directly connected to the grid (i.e. the output side is not connected to the low frequency isolation transformer), please ensure that the PV strings is not connected to the ground.
 F. If the inverter is for thin-film modules(grounded), please connect the output terminal after the low frequency isolation transformer and then boot, otherwise it will damage the inverter.
 G. The DC terminals used on inverter are mainly two kinds of types: Multi-Contact MC4 or Amphenol H4, the DC terminals connected to inverter and the terminals on inverter must use the same model and brand. If not, it may damage the inverter and bring additional maintenance costs or cause other losses. In this case, the company assume neither liability nor warranty.
 H. The picture below shows the DC connecting port on the DC side.

ATTENTION: Please confirm input DC polarity is correct before operation, connect positive electrode of PV modules to DC terminals labeled "+" on inverter, and the negative of PV modules connect to the DC terminals labeled "-".

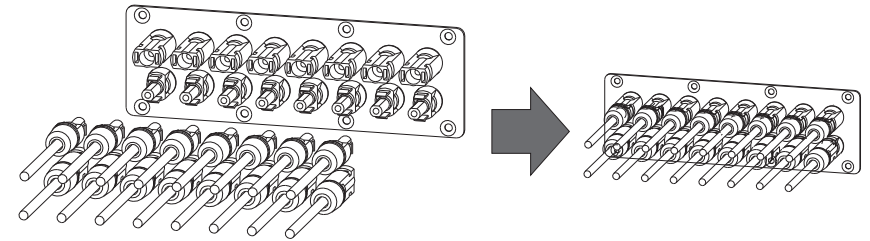

I. The maximum input current of per input refer to the following table:

MODEL	Max input current
17000-25000TL3-S	37.5A
30000TL3-S	34A
33000-50000TL3-(N)S	38A

J. Specification of DC cable :

MODEL	Cross-sectional area (mm ²)	recommend (mm ²)
17000-50000 TL3-(N)S	4-6	4

5.6 PV module setting

The location of the 2 bit switch is shown as below :

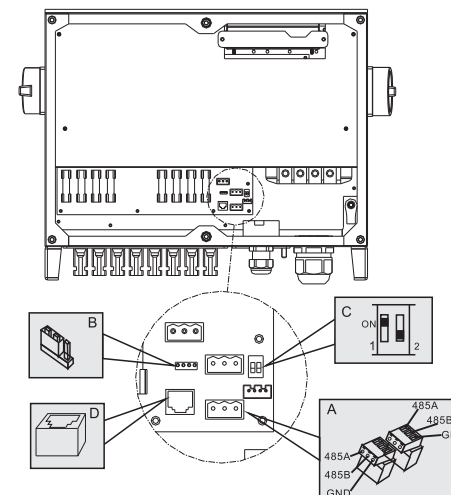

ITEM	Description
A	RS 485 port
B	RS 485 BUS balance jumper
C	2 bit switch of PV module setting
D	DRMS PORT

STATE OF SWITCH		DIAGRAM
S1	S2	
ON (Default)	OFF	
OFF	OFF	<p>STATE 1</p>
ON	OFF	
S1	S2	
ON	ON	
OFF	ON	<p>STATE 2</p>
ON	ON	
S1	S2	
ON	ON	
ON	ON	<p>When set the Growatt TL3-(N)S in parallel mode, you must use the standard line to connect PVA+ to PVB+, and PVA- to PVB-.</p> <p>Note: It is not recommended to use as this state in PV plant.</p> <p>It can be used in some special conditions such as in lab with DC source.</p> <p>STATE 3</p>
ON	ON	<p>STATE 4</p>

5.7 Communication connection

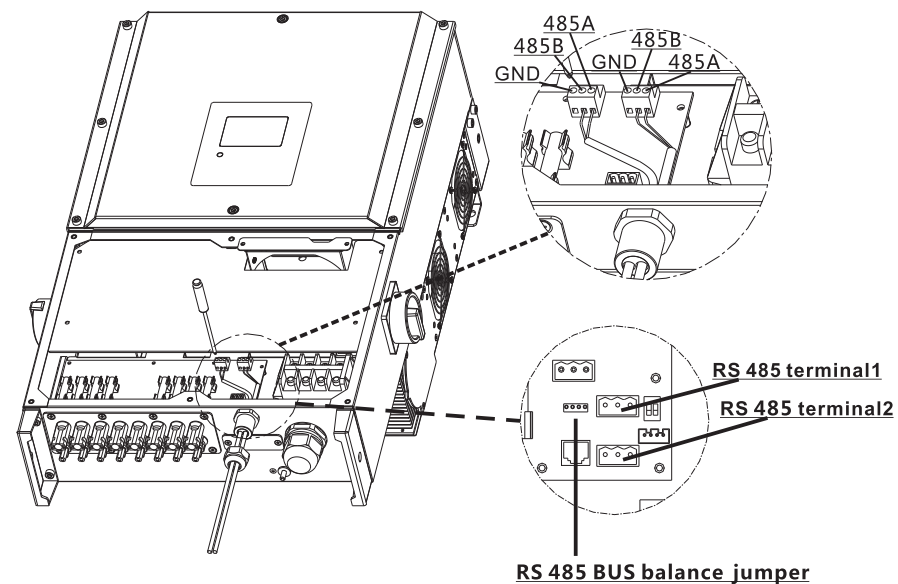

RS485 BUS balance jumper:

In RS485 communication circuit, when the T/R+ and T/R- lines reach a certain length (>328 feet), the line itself has impedance. In order to balance the impedance of the RS485 bus line, you must install the jumper to the "ON" state in RS485 BUS balance jumper of the remote inverter (last inverter before monitoring). So that the last inverter connects to the RS485 bus line while others stay in "ON" state.

The RS485 bus line is recommended not exceed 2,624ft when using the #20AWG RS485 communication standard line. Shielded twisted pair cable (STP), impedance 100...150 ohm is recommended.

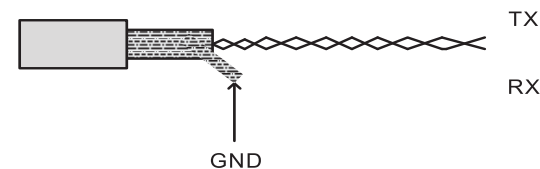

 NOTICE	<ul style="list-style-type: none"> In order to improve the Anti-jamming capability of RS485 communication, it is recommended that the GND terminal of the inverter which connects to the ShineWebBox must be connected to the EARTH. Adopting shielded twisted-pair cable and effectively grounded. In strong electric field location one must use galvanized tube shielding the twisted pair. The twisted pair should be away from the high tension line, high voltage power line and other signal line.
-------------------	---

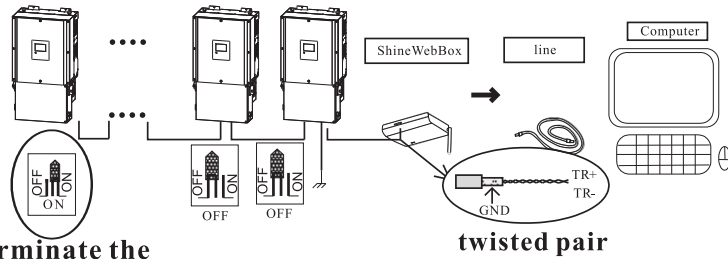

terminate the daisy chain

twisted pair

Rs485 Bus Connection via RS485 standard connector: connect three RS-485 leads : T/R+, T/R-, GND into position shown.

5.8 Inverter demand response modes (DRMs, only for Australia)

This series inverter has the function of demand response modes, moreover, We use RJ45 socket as inverter DRED connection.

5.8.1 RJ45 socket pin assignment

PIN	Assignment for inverterscapable of both charging and discharging	Pin Assignments Front View
1	DRM5	
2	DRM6	
3	DRM7	
4	DRM8	
5	RefGen	
6	COM/DRM0	
7	/	
8	/	

5.8.2 Method of asserting demand response modes

MODE	Rj45 socket Asserted by shorting pins		Requirement
DRM0	5	6	Operate the disconnection device
DRM5	1	5	Do not generate power
DRM6	2	5	Do not generate at more than 50% of rated power
DRM7	3	5	Do not generate at more than 75% of rated power AND Sink reactive power if capable
DRM8	4	5	Increase power generation (subject to constraints from other active DRMs)

5.9 Derating

Derating of the inverter is a method to avoid overload or restrain the potential danger, or to reduce the power generation according to the special requirement. The derating may be caused by the following reasons:

- Internal temperature is too high
- Integrated power module temperature is too high
- External instruction adjustment
- Input over voltage
- Output under voltage

5.9.1 Over temperature derating

- 1) The environmental temperature will lead to derating.
- 2) The inverter can maintain the internal temperature in a certain range itself, the system will derating to reduce the temperature if the internal temperature is too high. Therefore, it is necessary to select a right position to avoid direct sunlight before installing and running.
- 3) The machine derating automatic when the temperature exceeds a certain temperature range, so that it can achieve self protection to prevent over temperature damage, the following diagram defines power limit of the inverter under different conditions:

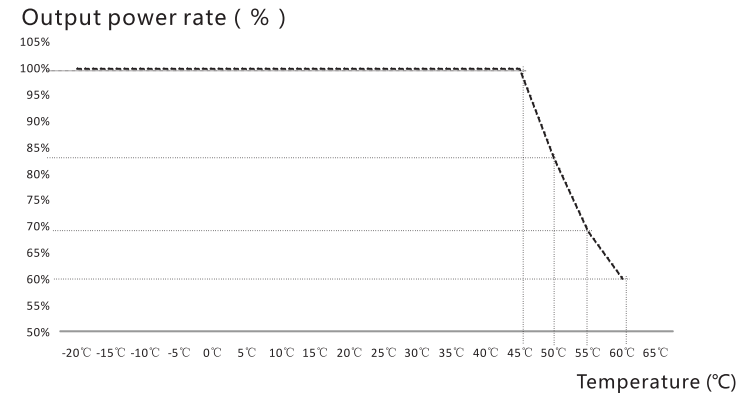



5.9.2 Command

The TL3-(N)S series inverter can limit its output power by software.

- 1) You can adjust the output power percentage through the monitoring system, ShineServer.
- 2) You can adjust the output power percentage through the matching software, ShineBus.

6 Comissioning

6.1 Check before comissioning

 DANGER	<ul style="list-style-type: none"> ● High voltage in the PV system risk of death or serious injury due to electric shock. ● Only electrically skilled persons may perform work on the PV array.
 WARNING	<ul style="list-style-type: none"> ● Under any condition! Make sure the maximum open circuit voltage of each PV string is less than 1000V.

Operation requirements:

- 1 Install location is suitable for operation and maintenance.
- 2 Confirm the inverter is firmly installed again.
- 3 Good airflow condition.
- 4 No objects or parts are left on the top of the inverter.
- 5 The inverter is connected properly with the surrounding accessories.
- 6 Cables are reasonable, and are well protected from mechanical damage.
- 7 AC circuit breaker used is reasonable.
- 8 Unused terminals have been sealed.
- 9 Safety signs and warning label on the inverter are pasted firmly and clearly.

Steps:

- 1 Check the location of the inverter, check whether it is grounded;
- 2 Turn AC switch to "ON" position;
- 3 Turn AC switch to "On" position , countdown for 30s;
- 4 Set the address of the inverter respectively after starting the inverter if more than one inverter need to be connected. The address of inverters connected together can not be repeated.(set Method refer to chapter 7.5.2)

6.2 Inverter installtion plan

6.2.1 Single inverter

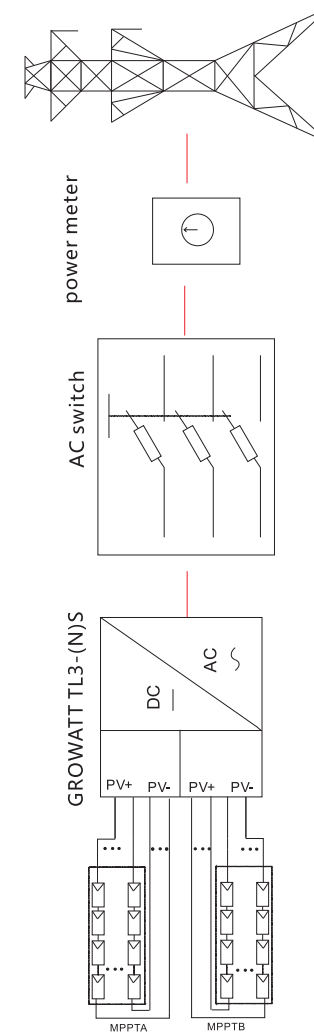

Display setting 7

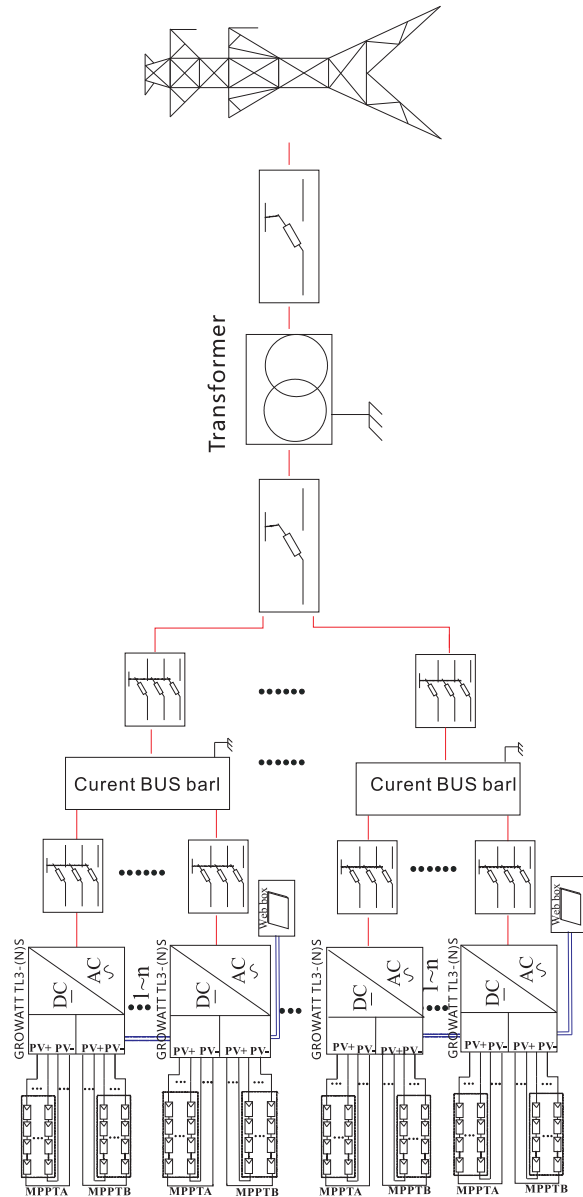

6.2.2 Multi inverter



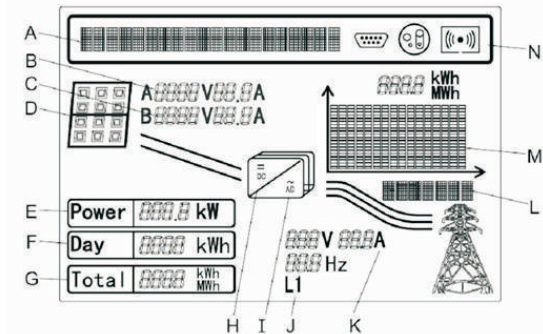

7.1 LCD display

LCD screen can display the working state of the inverter, historical generating capacity. You can check the operation information or set parameters of the inverter by knocking the cover.



Position	Detail
A	Text line for displaying an event
B	Input voltage and current of MPPT A
C	Input voltage and current of MPPT B
D	PV array A and B, lighted when the array voltage is above the start voltage(250V)
E	Current power
F	Daily energy
G	Total energy generated since the inverter was installed
H	Light when the array voltage is above the start voltage(250V)
I	Lighted when "H" is lighted and feed-in
J	Output phase of the line conductor, s J witch every 5 seconds.
K	Output voltage /current /frequency of the line conductor
L	Graphical display of the inverter energy/power
N	 RS232 communication
	 RS485 communication

N	 Internal wireless communication
	 External wireless communication



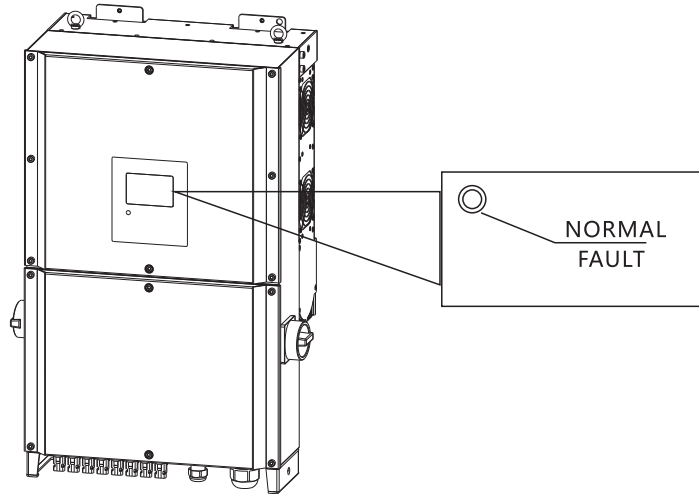









7.2 LED display

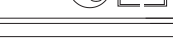

The LED also represents the status of the inverter.











LED color /status	Inverter status
Green/constant	Operation
Red/constant	<ul style="list-style-type: none"> • Fault– contact installer • Standby module
Red/flashing	<ul style="list-style-type: none"> • Warning– contact installer • Software update
Extinguished	countdown for 60s,standby

7.3 Inverter message

Description	Display
1.Knock on the enclosure lid once and the text line cycles to information as follow	Growatt Inverter 
2.Displaying the serial number of the inverter	SN: 1234567890 
3.Displaying the model of the inverter:	Model: GT0010F19A 
4.Displaying the power type of the inverter:	30000 TL3-S 
5.Displaying the software version of the inverter:	FW: TF1. 0-CF1. 0 
6.Working state of the inverter (shown as the right for example)	No AC Connection 
	PV Power Low 
7.Information of the "Anti-PID" and string monitor (shown as the right for example)	PID Waiting 
	PID Warning 
1.Countdown for 60s	Connect in 60s 
2.Green LED and and background light light up	Connect in 00s 
	Connect OK! 

Note: The user will not easy to read the information of inverter, such as state, input data, output data, power generation when the cloudy or the light is weak. In such a case, You can light the LCD through knock once on the inverter cover. You can change the interface, the backlight will be automatically closed if there is not any operation for 10s.

7.4 Knock once





Knock on the enclosure lid once at a time and the text line cycles to information about of the Growatt TL3-S:	Power Factor 1.0 
	Power Rate: 100%  • • • • •
Knock on the enclosure lid once, show as follow, String information	String Info 
Anti-PID information	PID Info 
BUS voltage	Bus+/-: 285V/284V 
Serial number	SN:1234567890 
Model number	Model:GT0010F19A 
Software version	FW:TF1.0-CF1.0 
Communication address	COM Address: 001 
Date and time	2016/01/01 00:00 
Setting	Setting... 

7.5 Knock repeatedly



The Text line is used for displaying an event. Include the information of setting language, models, communication address ,string information, PID information and time. You can operate the settings as follows.



Remark: Before setting the language, COM Address and time, you have to input the setting code.

7.5.1 Input setting code

1) Knock on the enclosure lid once at a time until the text line cycles to the text	Setting ... 
2) Knock on the enclosure lid twice and the text will display	Input 123 : 000 
3) Knock on the enclosure lid twice to let the higher number text "000" flash. Then knock on the enclosure lid once to change it from "000" to "100". For every knock the highest number text will add 1, the range of number text is 0~9. Then knock the lid twice to verify it.	Input 123 : 100 
4) The middle number will flash, change it the same as the first number. So does the third one.	Input 123 : 110 
✓ Then you can set the language, COM address and time.	





7.5.2 Setting language

1) Knock on the enclosure lid once at a time until the text line cycles to the text .	Set language 
2) Knock on the enclosure lid twice and the text will show the language .	Language:English 

3) You can choose the language by knocking the enclosure once; the language includes English, Dutch, Spanish, French, and Italian.	Setting ... 
4) Then you can knock the enclosure three times to confirm the language you have chosen. And the text line change	Set OK! 
<p>✓ The language is setting! You can knock the lid four times to quit the setting menu.</p>	

7.5.3 Setting com address







 INFORMATION	For the communicating, the inverter needs a communication address. In multi system, the addresses of inverters must be different from one to another.
--	---

1) Knock on the enclosure lid once at a time until the text line cycles to the text.	Com Address : 001 
2) Knock on the enclosure lid twice and the lower number text "1" will flash: 001. If you want to change it, knock on the enclosure lid once at a time to change it form: 0~9.	Com Address : 005 
3) If you want to set the address using more digits, knock on the enclosure lid twice to let the higher number text "002" flashing. And knock the enclosure lid once every time to change it form: 0~9. So as the highest number text. Usually, the inverter COM address is within 0-32.	Com Address : 015 
4) You can knock on the enclosure three times to confirm the COM Address you have chosen.	Setting ...  Set OK! 





✓ The Com Address is set!

You can knock the lid four times to quit the setting menu.















7.5.4 Setting date and time

1) Knock on the enclosure lid once at a time until the text line cycles to the text shown as the right (time displayed can differ depending on the inverter).	2012 /01 /01 00 :12 
2) Knock on the enclosure lid twice and cycles to the year "2015", and the two lower number "2015" will flash, then you can knock once at a time to change it.	2015 /01 /01 00 :12 
3) Knock on the enclosure lid twice and cycles to the month "01", and it will flash. Then you can knock once at a time to change it.	2015 /12 /01 10 :12 
4) Repeat to set the day and the time.	2015 /12 /25 10 :12 
5) Then knock on the enclosure three times to confirm.	Setting...  Set OK ! 
<p>✓ The date and the time is set! You can knock the lid four times to quit the setting menu.</p>	



















7.5.5 Check the string information







1) Knock on the enclosure lid once at a time until the text line cycles to the text as the right.	String Info 
2) Knock twice to enter the string information, shown as the right on cycle; Knock once to quit.	FW:NCAa0001  Str1: 025V 0.1A  ... Str8: 021V 0.5A 

If there is error information, it will be shown after software version one by one, and shown with the string information on cycle; knock once to quit; the following situation is the fault status that might happen.

Indicate which strings are reverse connected. For example, "PV12 Reverse" represents the 1st and 2nd strings are reverse.	Reverse:12345678   
Indicate which fuses are open. For example, "Fuse Open12" represents the 1st and 2nd fuse are open.	Fuse Open:12345678   
Indicate which strings are unusual. For example, "String Unusal 12" represents the 1st and 2nd strings are unusual.	String Unusal:12345678   
Indicate which strings are short. For example, "Str Short12" represents the 1st and 2nd strings are abnormal.	Str Short:12345678   
Indicate which strings are disconnected. For example, "Str Break 12" represents the 1st and 2nd strings are disconnected.	Str Break:12345678   

7.5.6 Check the PID information

1) Knock on the enclosure lid once at a time until the text line cycles to the text as the right.	PID Info   
2) Knock twice to enter, and the soft version and PID information are shown on the screen ; knock once to quit.	FW:NCAa0001    PID: 800V 0.3mA   
If there is error information, it will shown on the screen after software version, cyclely; Knock once to quit. (The following is the probable status shown on the the screen)	
Indicate which strings are reverse connected. For example, "PV12 Reverse" represents the 1st and 2nd strings are reverse.	PV 12 Reverse   
Indicate which strings are disconnected. For example, "PV12 Disconnect" represents the 1st and 2nd strings are disconnected.	PV 12 Disconnect   
Insulation resistance between the DC input with respect to ground is lower than limit.	ISO Error   

BUS voltage of PID is abnormal.	BUS Volt Abnormal   
Output of PID over voltage.	Output Over Volt   

7.6 Power generation graph

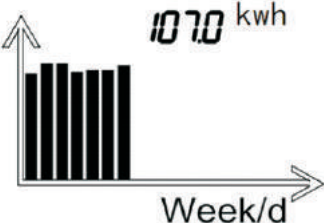
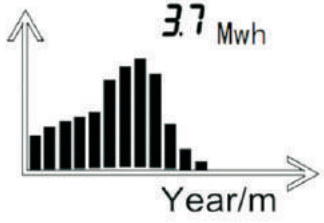
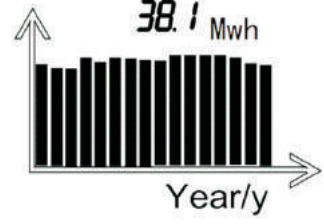
	The graph shows recent 16 hours of power generation and the maximum value power of the 16 values.
	The graph shows recent 7 days of power generation and the maximum value power of the 7 values.
	The graph shows recent 12 months of power generation and the maximum value power of the 12 values.
	The graph shows recent 16 years of power generation and the maximum value power of the 16 values.

8 Communication

This section is about the setting information of the inverter and the monitoring of the inverters.

8.1 Shinetool

Using ShineTool to set the information of the inverter

About the software of ShineTool and the usage of it please download from the web: www.growatt.com



The connecting diagram as follows:

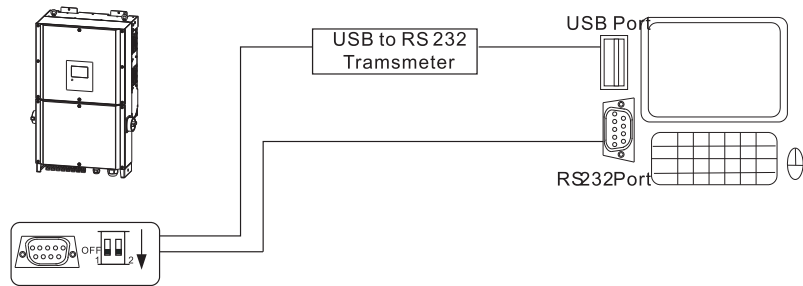

8.2 Monitor the inverters

8.2.1 Monitor the inverters with RS485

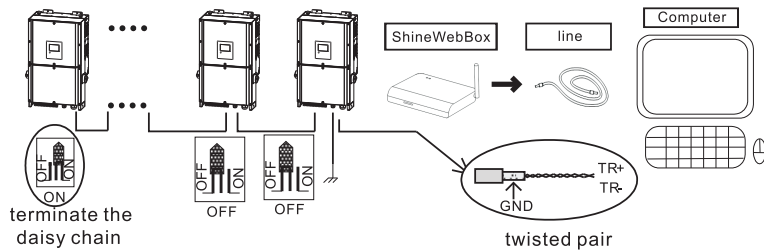
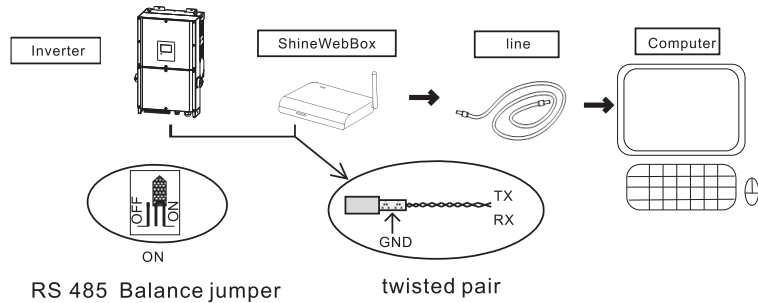

Monitor 2~26 inverter wire diagram

About the RS485 connector and the connection, you can go back to the section 5.7 for details. The above figure shows the diagram of monitoring inverters with ShineWeBox. Generally, the maximum number of the inverter is 26.

	<ul style="list-style-type: none"> • In general, when using the RS485, every inverter must have different com address. You can go back to the section 5.7 for details. • More information about the ShineWeBox go to the web: Http://www.growatt.com
--	---

8.2.2 Monitor the inverters with External wireless.

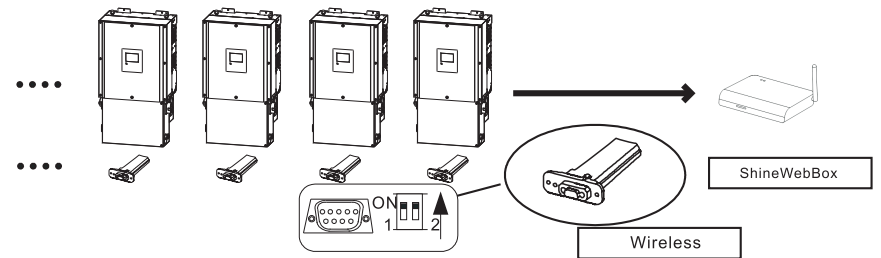

The figure shows the wiring schematic of monitoring inverters with Zigbee and ShineWebBox. Generally, the maximum number of the inverters is 15. The communication distance between the Zigbee and the ShineWebBox is 984 feet in the open space.

	<ul style="list-style-type: none"> • About the External Wireless section, you can go back to the section 5.4&5.5for details. • More information about the Zigbee and ShineWebBox go to the web: Http://www.growatt.com
--	---

9 Booting and shutdown

9.1 Display and message

 WARNING	<ul style="list-style-type: none"> • Make sure the inverter has connected DC and AC conductor cables correctly according to the wiring diagram of section 5.4&5.5. • Under any condition! Make sure the maximum open circuit voltage (Voc) of each PV string is less than 1000VDC.
---	--

When the PV input voltage is above 200V, the inverter can be powered on.

- > Turn the DC rotary switch from the off position “O” to the on position “I” as shown in 9.2.
- > The text line of the LCD must display the information as shown below in proper sequence:

SN:XXXXXXXXXX	  
Model: GT00X0XXXX	  
33000 TL3-S	  
FW:XXX.X-XX.X	  

- > The display will then cycle and the text line will display the information below the LED will turn to red:

No AC Connection	  
------------------	---

In order to connect to AC grid you must turn on AC disconnect.

Once the inverter is operating in a normal status, before it's connected to the grid, it will take 60 seconds to check the inverter including the GFCI automatically.

- > The LCD text line's information display as below:

Connect in 60s	  
----------------	---

- > When it counts to 0s, the inverter attempts to connect to the grid. Once it outputs power to the grid successfully, the text line in the LCD will display as shown below:

Connect OK!	  
-------------	---

The LED will light green.



- > Booting the Growatt TL3-(N)S successfully!

9.2 Turn off the Growatt TL3-(N)S

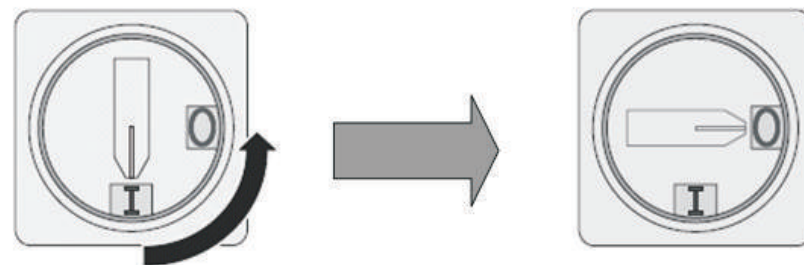
- > Turn the DC rotary switch from the ON position “I” to the OFF position “O” as shown below.



- > Wait until the text line of the LCD displays as shown below:

PV Power Low	  
--------------	---

The LED will light red.

In this state, it is working in a standby, isolated from the DC power.

- > Turn off the AC connector until the LCD and the LED are powered off (NO DISPLAY).
- ✓ Shutdown the inverter successfully!

	<ul style="list-style-type: none"> • For safety, do not open wire box until 10 minutes passed.
---	---

10 Maintenance

10.1 Daily maintenance

10.1.1 Inverter cleaning



DANGER

- Before any operation, please disconnect the DC switch and AC switch, and wait for at least 10 min until the internal bus capacitance discharge completely.

- 1) Check the ambient humidity and dust of the inverter, and clean the inverter when necessary.
- 2) Observe whether the air outlets is normal. When necessary, clean the air outlets or clean the fan step by step, steps refer to 8.1.3.

10.1.2 Inverter storage

- 1) Please choose a suitable location if you need to store the inverter in the warehouse for a long time.
- 2) The inverter must be placed in the original packaging. Please keep the environment dry.
- 3) The restore temperature should between -40°C and 60°C , relative humidity between 0% to 100%.
- 4) Number of stacked inverters should be no more than 4 if you have a number of inverters to be stored.
- 5) After a long time storage, inverter should be tested before using .

10.1.3 Fan maintenance



DANGER

- It must be carried out by qualified, trained personnel and comply with all prevailing local codes and regulations. Please disconnect the DC switch and AC switch before any operation, and wait for at least 10 minutes until the internal bus capacitance discharge completely.

When the growatt TL3-(N)S series inverter work in high temperature environment, good ventilation and heat dissipation can effectively reduce the chance of load derating. Inverter equipped with internal cooling fans, when the internal temperature is too high, the fans work in to reduce the internal temperature. When the inverter derating because of the internal temperature is too high , the following are the possible reasons and solutions.

- Fan is blocked or the heat sink gathers too much dust, it needs to clean the fan, fan cover or heat sink.
- Fan is damaged, it needs to replace the fan.
- Poor ventilation of the installation location, it needs to select the appropriate installation location according to the basic installation requirements.

Fan cleaning and replacement procedure:

1. Please ensure that the DC side and AC side of the inverter have been disconnected before cleaning or replacement of the fan;

1. Turn off both DC and AC switch for at least 10min.

2. Remove the screws on the fan guards as shown below.

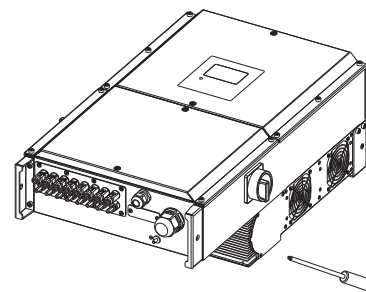

3. Disconnect the wire connector of the fans using a flat head screwdriver and remove the fans from the fan guards. It is shown as below:

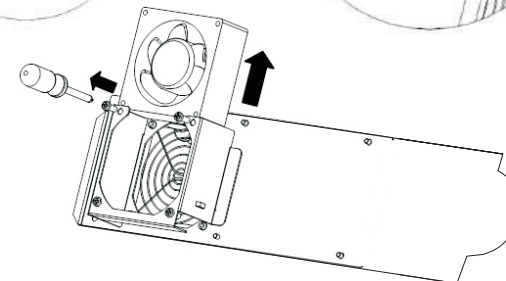
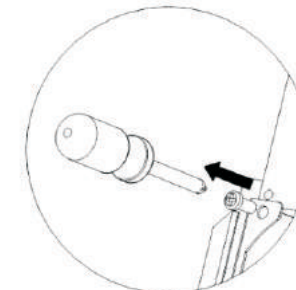
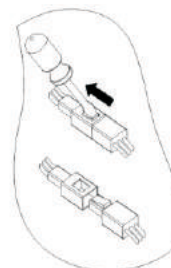

4. Clean fan, fan guard and heat sink or replace fan;

- 1) Clean the fan and fan guard with air pump, brush or a damp cloth;
- 2) Remove each fan separately for cleaning if necessary;
- 3) Remove the fan that need to replace with a cross screwdriver;
- 4) Replace the new fan;
- 5) Tidy up the wire;

5. Install the fan/fan guard fixed and the inverter again.

10.1.4 Fuse replacement



DANGER

- It must be carried out by qualified, trained personnel and in compliance with all prevailing local codes and regulations.
- Before any operation, please disconnect the DC switch and AC switch, and waiting for at least 10 min until the internal bus capacitance discharge completely.

steps of replacement:

- > Disconnect the DC switch and AC switch, and waiting for at least 10 min.
- > Open the wire box carefully.
- > Check the broken fuse and remove it carefully.

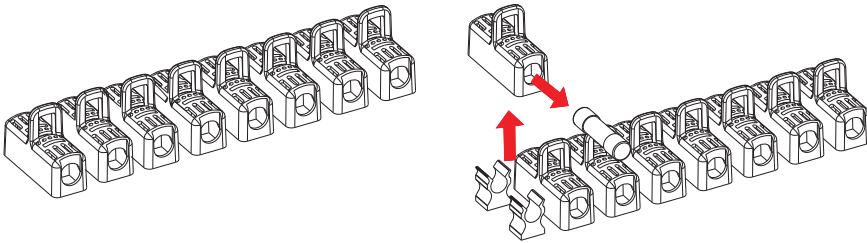

- > Replace a new one.

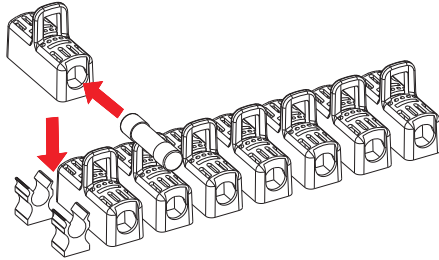

- > Close the wire box.

10.2 Error and warning



DANGER

- > Normally grounded conductors may be ungrounded and energized when a PV Isolation Low is indicated.
- Risk of electric shock.
- Test before touching.
- Work on the Growatt TL3-(N)S must be carried out by qualified personnel.

The system status is identified through warning or error signals displayed on the LCD display and the LED. The following tables briefly describe the two types of signals which may be displayed.

10.2.1 warning

Warnings (W) identify the current status of the inverter. Warnings do not relate to a fault and it does not affect the normal running of the inverter. When a (W) with a number after it appears in the display, it indicates a Warning Code and is usually cleared through an orderly shutdown/re-set or a self-corrective action performed by the inverter.

See the (W) codes in the following table.

Warning message	Description	Suggestion
Warning 100	The problem of fan(s)	See Note1 below the chart
Warning 101	Not choose the correct PID mode	Please refer to the manual to choose the correct PID mode
Warning 102	Not choose the correct String mode	Please refer to the manual to choose the correct String mode
Warning 103	Reading EEPROM fail	Restart inverter
Warning 104	DSP and COM firmware version unmatched	Contact Growatt
Warning 105	Writing EEPROM fail	Restart inverter
Warning 106	SPD fault	Contact Growatt
Warning 108	PV is short	Check PV connection
Warning 109	BOOST drive abnormal	Contact Growatt
StrUnusaul/Warning	String current is abnormal/Solar panel is unmatched	Check the PV modules and string
StrFuseOpen Warning	Fuse is damage	Check the fuses
PID Warning	PID Warning	Contact Growatt

If the suggestions do not work, please contact to the Growatt.

Note 1: The Growatt TL3-(N)S has three fans (one internal and two outside).

Fan	Internal	Outside A	Outside B
Fault Message of LCD show	WARNING: FAN 3	WARNING: FAN 1	WARNING: FAN 2
	WARNING: FAN 1,3		\
	\	WARNING: FAN 1,2	
	WARNING: FAN2,3	\	WARNING: FAN2,3
	WARNING: FAN 1,2,3		

Once the internal fan of Growatt TL3-(N)S has Error, the inverter can still operate; if the outside fan(s) has Error(s), the inverter can still operate, but the power it feeds back to the grid is limited to the temperature itself.

So, if the internal fan has Error, you should contact Growatt to replace the internal fan, do not replace it by yourself!

If the outside fan(s) has problems, connect to the supplier or Growatt to replace by qualified personnel.

10.2.2 Errors(E)

Errors (E) codes identify a possible equipment failure, fault or incorrect inverter setting or configuration.

Any and all attempts to correct or clear a fault must be performed by qualified personnel.

Typically, the (E) code can be cleared once the cause or fault is removed.

Some of the (E) code Error as table shows below, may indicate a fatal error and require you to contact the supplier or Growatt for replacement.

Error code	Meanings	Suggestion
Error 101	Internal communication with host failed	Contact Growatt
Error 106	Redundant sample circuit of Insulation values are different	Contact Growatt
Error 107	Redundant sample circuit of GFCI values are different	Contact Growatt
Error 108	Internal power test fail	Contact Growatt
Error 111	IGBT drive fault	Contact Growatt
Error 112	AFCl test fail, System PV circuitry exist Arc	Contact Growatt
Error 114	AFCl self-checking fail	Contact Growatt
Error 117	Inverter relay fault	Contact Growatt
Error 121	Internal communication with slave failed	Contact Growatt
Error 122	Internal bus over/under voltage.	Contact Growatt
StrReverse Error	The string is reverse	Check the string connection

Error code	Meanings	Suggestion
StrShort Error	The string is short circuit	Check the string connection
No AC Connection	The inverter not detected grid voltage	Check the grid connection
PV Isolation Low	PV isolation resistance is outrange	Contact Growatt
Residual I High	Redidual current is outrange	Contact Growatt
Output high DCI	Output current DC component outrange	Contact Growatt
PV Voltage High	PV input voltage is above 1000V	Check the solar panel configuration and wiring
AC V Outrange	The grid voltage is outrange	Check the grid voltage by the LCD
AC F Outrange	The grid frequency is outrange	Check the grid frequency by the LCD
PV SW Set Error	PV module set wrong	Check PV wiring and refer to chart5.6: PV module setting

12 Specification



INFORMATION

- Please control the input and output conditions within the range.

Growatt	17000TL3-S	20000TL3-S	25000TL3-S
Input data			
Max. recommend PV power	21250W	25000W	31250W
Max. DC power	17300W	20400W	25500W
Max. DC voltage	1000V		
Start voltage	250V		
DC nominal voltage	580V	580V	580V
PV voltage range	200V-1000V		
MPP voltage range (Full load)	400V-800V	400V-800V	400V-800V
Max. input current of the MPP tracker A/tracker B	37.5A	37.5A	37.5A
Max. input short circuit current	45A		
Number of MPP trackers	2		
Max. number of parallel strings per MPPT	3		
Output data			
Nominal output power	17000W	20000W	25000W
Max. apparent power	18800VA	22200VA	27700VA
Nominal AC voltage	230V/400V	230V/400V	230V/400V
AC voltage range	340-440VAC	340-440VAC	340-440VAC
Nominal AC grid frequency	50/60 Hz		
AC grid frequency range	45~55Hz/55-65 Hz		
Max. output current (cos φ=1)	27.5A	32.2A	40.3A
Power factor (cos φ=1)	0.8leading - 0.8lagging		
Harmonics	<3%		
Grid connection type	3W+N+PE	3W+N+PE	3W+N+PE
Efficiency			
Max efficiency	98.70%	98.70%	98.70%
EURO-Weighted Efficiency	98.40%	98.40%	98.50%

Growatt	17000TL3-S	20000TL3-S	25000TL3-NS
MPPT efficiency	99.5%		
Protect devices			
DC reverse-polarity protection	YES		
DC switch	YES		
Input over voltage protection	YES (CLASSII)		
DC insulation measure	YES		
RCD protection	YES		
AC short circuit protection	YES		
Output over voltage protection	YES (CLASSII)		
String fuse type/size	YES(15A/1000VDC)		
String monitor	YES		
Anti-PID	YES		
Arc detection(AFCl)	OPT. (compliant to UL 1699B)		
General data			
Dimensions(W*H*D)	470*754*270mm		
Weight	48kg		
Operation ambient Temperature range	-25°C to +60°C (derating over 45°C)		
Noise emission	≤50dB(A)		
Relative Humidity	0 to 100%		
Altitude	4000m		
Self-Consumption night	less than 1W(Note1)		
Topology	Transformerless		
Cooling concept	Fan Cool		
Environmental protection rating	IP 65		
Warranty:5years/ 10years	yes/opt		
Display and communication			
Display	LED+LCD		
RS 232	YES		
RS 485	YES		
WIFI	OPT.		
Note1. self-consumption less than 6W when AC power supply at night			

Growatt	30000TL3-S	33000TL3-S	40000TL3-NS	50000TL3-S
Input data				
Max. recommend PV power	37500W	41250W	50000W	60000W
Max. DC power	30700W	33700W	40800W	51000W
Max. DC voltage	1000V			
Start voltage	250V			
DC nominal voltage	580V	580V	580V	695V
PV voltage range	200V-1000V			
MPP voltage range (Full load)	450V-800V	450V-800V	540V-800V	645V-850V
Max. input current of the MPP tracker A/tracker B	34A	38A	38A	38A
Max. input short circuit current	64A			
Number of MPP trackers	2			
Max. number of parallel strings per MPPT	4			
Output data				
Nominal output power	30000W	33000W	40000W	48000W
Max. apparent power	33300VA	36600VA	44400VA	53300VA
Nominal AC voltage	230V/400V	230V/400V	230V/400V	277V/480V
AC voltage range	340-440VAC	340-440VAC	340-440VAC	422-528VAC
Nominal AC grid frequency	50/60 Hz			
AC grid frequency range	45~55Hz/55-65 Hz			
Max. output current (cos φ=1)	44A	48A	58A	58A
Power factor (cos φ=1)	>0.99(0.8LG - 0.8LD)			
Harmonics	<3%			
Grid connection type	3W+N+PE	3W+N+PE	3W+N+PE	3W+PE or 3W+N+PE
Efficiency				
Max efficiency	98.90%	98.90%	98.90%	99.0%
EURO-Weighted Efficiency	98.40%	98.40%	98.50%	98.50%

Growatt	30000TL3-S	33000TL3-S	40000TL3-NS	50000TL3-S
MPPT efficiency	99.5%			
Protect devices				
DC reverse-polarity protection	YES			
DC switch	YES			
Input over voltage protection	YES (CLASSII)			
DC insulation measure	YES			
RCD protection	YES			
AC short circuit protection	YES			
Output over voltage protection	YES (CLASSII)			
String fuse type/size	YES(15A/1000VDC)			
String monitor	YES			
Anti-PID	YES			
Arc detection(AFCI)	OPT. (compliant to UL 1699B)			
General data				
Dimensions(W*H*D)	470*754*270mm			
Weight	48kg			
Operation ambient Temperature range	-25°C to +60°C (derating over 45°C)			
Noise emission	≤50dB(A)			
Relative Humidity	0 to 100%			
Altitude	4000m			
Self-Consumption night	less than 1W(Note1)			
Topology	Transformerless			
Cooling concept	Fan Cool			
Environmental protection rating	IP 65			
Warranty:5years/ 10years	yes/opt			
Display and communication				
Display	LED+LCD			
RS 232	YES			
RS 485	YES			
WIFI	OPT.			
Note1. self-consumption less than 6W when AC power supply at night				

12 Quality assurance



INFORMATION

- If the size or parameter of the product changes, please refer to the company's latest information or specifications.

During the warranty period, Our company will offer repairment or replacement for free.

Requirement

During the warranty period, the user is required to provide the invoice and date of the purchase of the product. And the trademark on the product should be clearly visible, otherwise we have the right not to offer quality assurance. The product that has been replaced should be handled by the company, and we should be given a certain time to deal with the fault.

Responsibility immunity

In the following cases, our company assume neither liability nor warranty:

- Beyond the warranty period.
- Incorrect installation, modification.
- Beyond the very harsh environment described in this manual.
- Damage or malfunction caused by operation without permission.
- Damage or malfunction caused by using nonstandard parts or software.
- Damage or malfunction caused by natural disaster or other non-resistance factor.
- The installing and working condition or environment is not conform to local laws and regulations.

If the product damage is caused by above circumstances, we can provide paid services after the judgement of our company's service center.

Contact 13

If you have technical problems concerning our products, contact your installer or Growatt. Please provide information below for better support:

- Inverter type
- Serial number of Inverter
- Error code of Inverter
- Display of inverter
- Modules information
- Communication method

SHENZHEN GROWATT NEW ENERGY TECHNOLOGY CO.,LTD

No.28 Guangming Road,Shiyan Street,Bao'an District,Shenzhen,
P.R.China

T +86 755 27471942

E service@ginverter.com

W www.ginverter.com